

# P8

# Engineering Operation & Maintenance

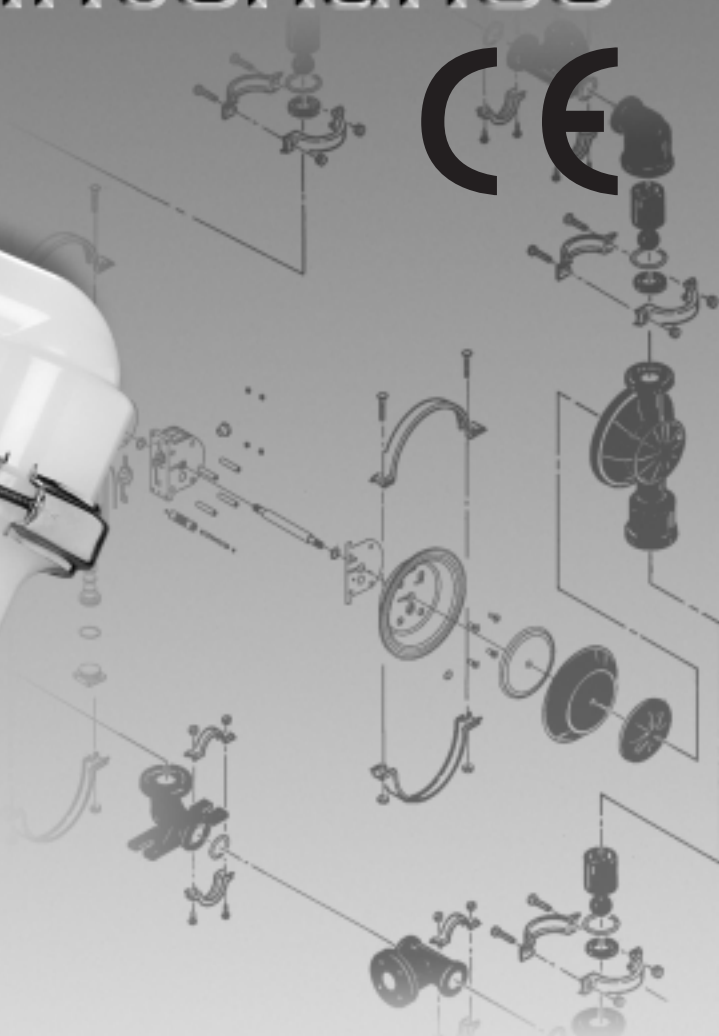

**PROFLO™**  
PROGRESSIVE PUMP TECHNOLOGY

**Plastic  
Pumps**

# TABLE OF CONTENTS

	PAGE #
<b>SECTION # 1 — PUMP DESIGNATION SYSTEM</b> .....	1
<b>SECTION # 2 — HOW IT WORKS (PUMP &amp; AIR SYSTEMS)</b> .....	2
<b>SECTION # 3 — CAUTIONS</b> .....	3
<b>SECTION # 4 — DIMENSIONAL DRAWINGS</b>	
A. Model P8 PLASTIC .....	4
<b>SECTION # 5 — PERFORMANCE CURVES</b>	
A. Model P8 PLASTIC Rubber-Fitted .....	5
B. Model P8 PLASTIC Ultra-Flex™-Fitted .....	5
C. Model P8 PLASTIC TPE-Fitted .....	6
D. Model P8 PLASTIC Teflon®-Fitted .....	6
<b>SECTION # 6 — SUCTION LIFT CURVES &amp; DATA</b> .....	7
<b>SECTION # 7 — INSTALLATION &amp; OPERATION</b>	
A. Installation.....	8
B. Operation & Maintenance.....	9
C. Troubleshooting .....	10
<b>SECTION # 8 — DIRECTIONS FOR DISASSEMBLY/REASSEMBLY</b>	
A. Model P8 PLASTIC .....	11
B. Pro-Flo™ Air Valve/Center Block — Disassembly, Cleaning, Inspection.....	14
C. Reassembly Hints & Tips.....	16
D. Teflon® Gasket Kit Installation.....	17
<b>SECTION # 9 — EXPLODED VIEW/PARTS LISTING</b>	
A. Model P8 PLASTIC Rubber/TPE-Fitted .....	18
B. Model P8 PLASTIC Teflon®-Fitted .....	20
<b>SECTION # 10 — ELASTOMER OPTIONS</b> .....	22

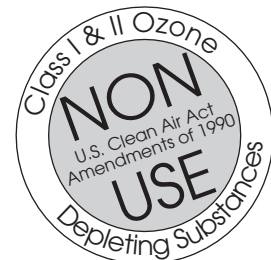

# SECTION 1

# WILDEN PUMP DESIGNATION SYSTEM

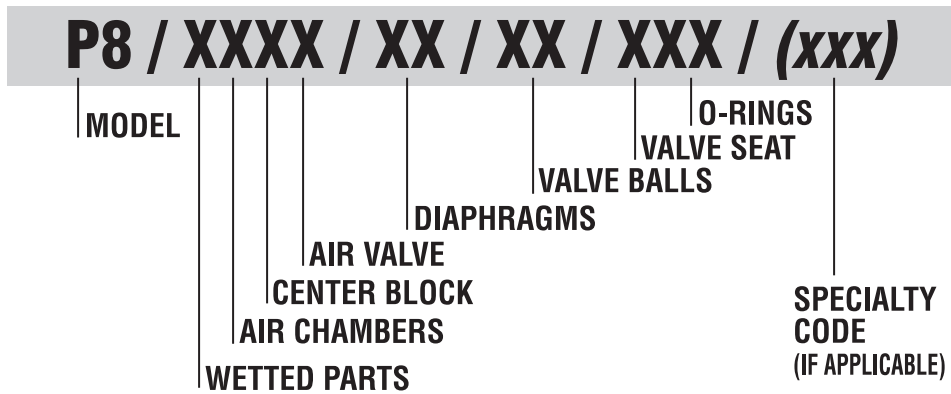

## SECTION 2

# THE WILDEN PUMP — HOW IT WORKS

The Wilden diaphragm pump is an air-operated, positive displacement, self-priming pump. These drawings show flow pattern through the pump upon its initial stroke. It is assumed the pump has no fluid in it prior to its initial stroke.

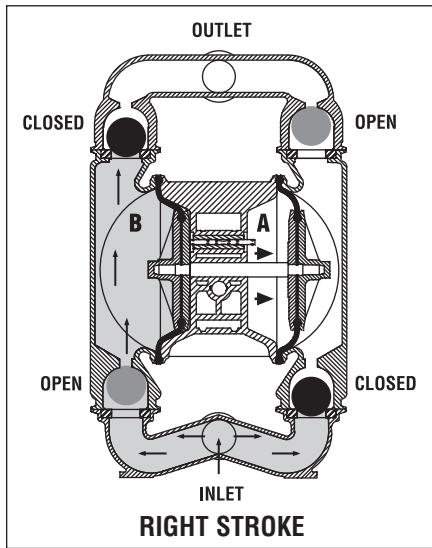

FIGURE 1 The air valve directs pressurized air to the back side of diaphragm A. The compressed air is applied directly to the liquid column separated by elastomeric diaphragms. The diaphragm acts as a separation membrane between the compressed air and liquid, balancing the load and removing mechanical stress from the diaphragm. The compressed air moves the diaphragm away from the center block of the pump. The opposite diaphragm is pulled in by the shaft connected to the pressurized diaphragm. Diaphragm B is on its suction stroke; air behind the diaphragm has been forced out to the atmosphere through the exhaust port of the pump. The movement of diaphragm B toward the center block of the pump creates a vacuum within chamber B. Atmospheric pressure forces fluid into the inlet manifold forcing the inlet valve ball off its seat. Liquid is free to move past the inlet valve ball and fill the liquid chamber (see shaded area).

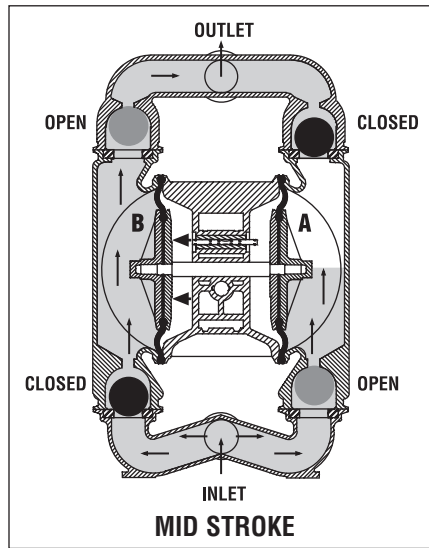

FIGURE 2 When the pressurized diaphragm, diaphragm A, reaches the limit of its discharge stroke, the air valve redirects pressurized air to the back side of diaphragm B. The pressurized air forces diaphragm B away from the center block while pulling diaphragm A to the center block. Diaphragm B is now on its discharge stroke. Diaphragm B forces the inlet valve ball onto its seat due to the hydraulic forces developed in the liquid chamber and manifold of the pump. These same hydraulic forces lift the discharge valve ball off its seat, while the opposite discharge valve ball is forced onto its seat, forcing fluid to flow through the pump discharge. The movement of diaphragm A toward the center block of the pump creates a vacuum within liquid chamber A. Atmospheric pressure forces fluid into the inlet manifold of the pump. The inlet valve ball is forced off its seat allowing the fluid being pumped to fill the liquid chamber.

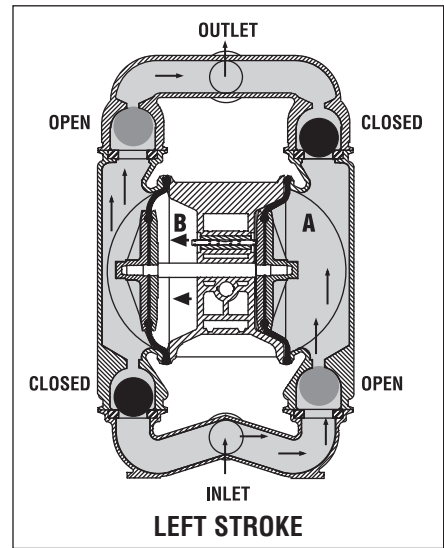

FIGURE 3 At completion of the stroke, the air valve again redirects air to the back side of diaphragm A, which starts diaphragm B on its exhaust stroke. As the pump reaches its original starting point, each diaphragm has gone through one exhaust and one discharge stroke. This constitutes one complete pumping cycle. The pump may take several cycles to completely prime depending on the conditions of the application.

## PRO-FLO™ AIR DISTRIBUTION SYSTEM OPERATION — HOW IT WORKS

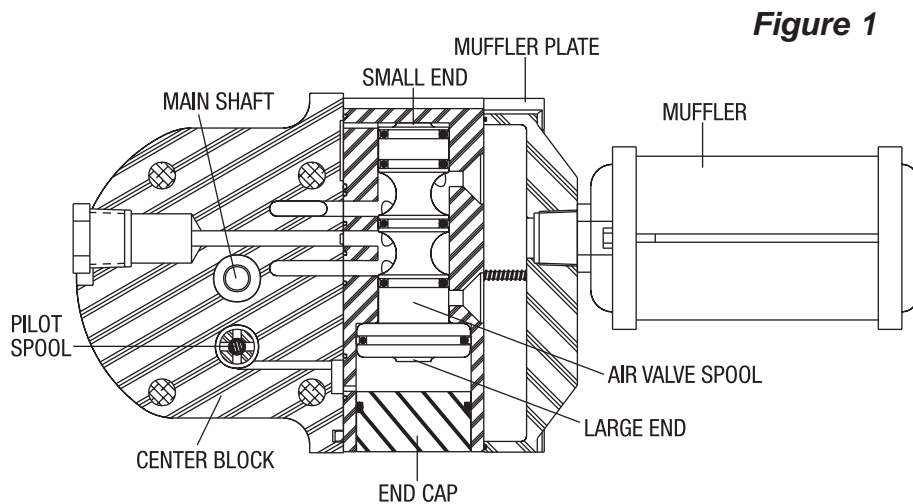



Figure 1

The Pro-Flo™ patented air distribution system incorporates three moving parts: the air valve spool, the pilot spool, and the main shaft/diaphragm assembly. The heart of the system is the air valve spool and air valve. As shown in Figure 1, this valve design incorporates an unbalanced spool. The smaller end of the spool is pressurized continuously, while the large end is alternately pressurized and exhausted to move the spool. The spool directs pressurized air to one chamber while exhausting the other. The air causes the main shaft/diaphragm assembly to shift to one side — discharging liquid on one side and pulling liquid in on the other side. When the shaft reaches the end of its stroke, it actuates the pilot spool, which pressurizes and exhausts the large end of the air valve spool. The pump then changes direction and the same process occurs in the opposite direction, thus reciprocating the pump.

## SECTION 3

# WILDEN MODEL P8 PLASTIC CAUTIONS – READ FIRST!

 **CAUTION:** Do not apply compressed air to the exhaust port — pump will not function.

 **CAUTION:** Do not over lubricate air supply — excess lubrication will reduce pump performance.

### TEMPERATURE LIMITS:

Polypropylene	0°C to 79°C	32°F to 175°F
PVDF	-12°C to 107°C	10°F to 225°F
Neoprene	-17.7°C to 93.3°C	0°F to 200°F
Buna-N	-12.2°C to 82.2°C	10°F to 180°F
Norde <sup>l</sup>	-51.1°C to 137.8°C	-60°F to 280°F
Viton <sup>®</sup>	-40°C to 176.7°C	-40°F to 350°F
Wil-Flex <sup>™</sup>	-40°C to 107.2°C	-40°F to 225°F
Saniflex <sup>™</sup>	-28.9°C to 104.4°C	-20°F to 220°F
Polyurethane	-12.2°C to 65.6°C	10°F to 150°F
Tetra-Flex <sup>™</sup>	4.4°C to 107.2°C	40°F to 225°F
Teflon <sup>®</sup> PTFE	4.4°C to 104.4°C	40°F to 220°F

 **CAUTION:** When choosing pump materials, be sure to check the temperature limits for all wetted components. Example: Viton<sup>®</sup> has a maximum limit of 176.7°C (350°F) but polypropylene has a maximum limit of only 79°C (175°F).

 **CAUTION:** Maximum temperature limits are based upon mechanical stress only. Certain chemicals will significantly reduce maximum safe operating temperatures. Consult engineering guide for chemical compatibility and temperature limits.

 **CAUTION:** Always wear safety glasses when operating pump. If diaphragm rupture occurs, material being pumped may be forced out air exhaust.

 Plastic series pumps are made of virgin plastic and are not UV stabilized. Direct sunlight for prolonged periods can cause deterioration of plastics.

 **WARNING:** Prevention of static sparking — If static sparking occurs, fire or explosion could result. Pump, valves, and containers must be grounded when handling flammable fluids and whenever discharge of static electricity is a hazard. To ground the Wilden “Champ,” all clamp bands must be grounded to a proper grounding

 point.

 **CAUTION:** Do not exceed 8.6 Bar (125 psig) air supply pressure.

 **CAUTION:** Before any maintenance or repair is attempted, the compressed air line to the pump should be disconnected and all air pressure allowed to bleed from pump. Disconnect all intake, discharge and air lines. Drain the pump by turning it upside down and allowing any fluid to flow into a suitable container.

 **CAUTION:** Blow out air line for 10 to 20 seconds before attaching to pump to make sure all pipeline debris is clear. Use an in-line air filter. A 5 micron air filter is recommended.

 **NOTE:** When installing Teflon<sup>®</sup> diaphragms, it is important to tighten outer pistons simultaneously (turning in opposite directions) to ensure tight fit.

 **NOTE:** P8 PVDF pumps come standard from the factory with expanded Teflon<sup>®</sup> gaskets installed in the diaphragm bead of the liquid chamber, in the T-section and in the ball and seat area. Teflon<sup>®</sup> gaskets cannot be re-used. Consult PS-TG for installation instructions during reassembly.

 **NOTE:** Before starting disassembly, mark a line from each liquid chamber to its corresponding air chamber. This line will assist in proper alignment during reassembly.

 **CAUTION:** The P8 Plastic pump is not submersible. If your application requires your pump to be submersed, the T8 model can be used.

 **CAUTION:** Pumps should be flushed thoroughly with water before installation into process line.

 **CAUTION:** Tighten all hardware prior to installation.

# SECTION 4

# DIMENSIONAL DRAWING

## MODEL P8 PLASTIC PUMP

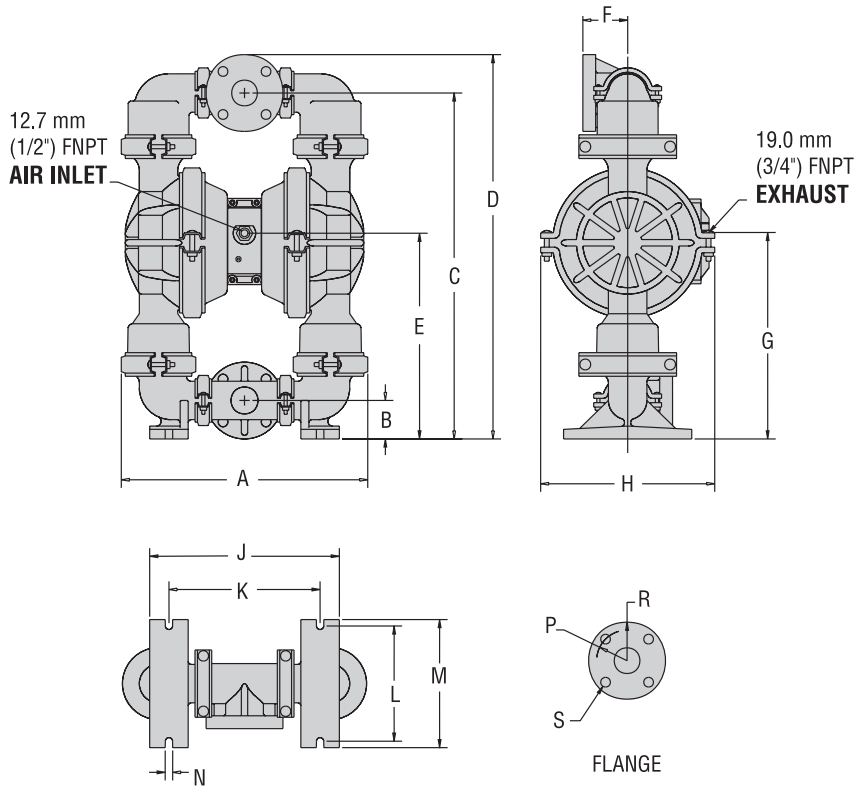

DIMENSIONS – P8 PLASTIC		
ITEM	METRIC (mm)	STANDARD (inch)
A	491.4	19.34
B	77.0	3.03
C	693.0	27.28
D	770.0	30.31
E	409.6	16.12
F	88.9	3.50
G	366.7	16.43
H	332.65	13.09
J	836.6	15.21
K	306.4	12.06
L	228.6	9
M	254.0	10
N	14.3	.56
	METRIC (mm)	STANDARD (inch)
P	60.3 RAD.	2.37 RAD.
R	76.2 RAD.	3.03 RAD.
S	19.8 RAD.	.78 DIA.



## SECTION 5A

# PERFORMANCE CURVES

## MODEL P8 PLASTIC RUBBER-FITTED

Height.....77.0 cm(30<sup>5</sup>/<sub>16</sub>" )  
 Width.....49.1 cm (19<sup>1</sup>/<sub>2</sub>" )  
 Depth.....33.2 cm (13<sup>3</sup>/<sub>2</sub>" )  
 Ship Weight..Polypropylene 33.8 kg (74.6 lbs.)  
                   PVDF 42.9 kg (94.6 lbs.)  
 Air Inlet.....1.27 cm (1/2" )  
 Inlet.....5.08 cm (2" )  
 Outlet.....5.08 cm (2" )  
 Suction Lift .....7.0 m Dry (23' )  
                   9.45 m Wet (31' )

Displacement per  
 Stroke ..... 2.91 l (.77 gal.)<sup>1</sup>  
 Max. Flow Rate.....586.7 l/m (155 gpm)  
 Max. Size Solids.....6.35 mm (1/4" )  
<sup>1</sup>Displacement per stroke was calculated at 4.8 Bar (70 psig) air inlet pressure against a 2 Bar (30 psig) head pressure.

**Example:** To pump 291.5 lpm (77 gpm) against a discharge pressure head of 2.0 Bar (30 psig) requires 4.1 Bar (60 psig) and 68 Nm<sup>3</sup>/h (40 scfm) air consumption. (See dot on chart.)

**Caution: Do not exceed 8.6 Bar (125 psig) air supply pressure.**

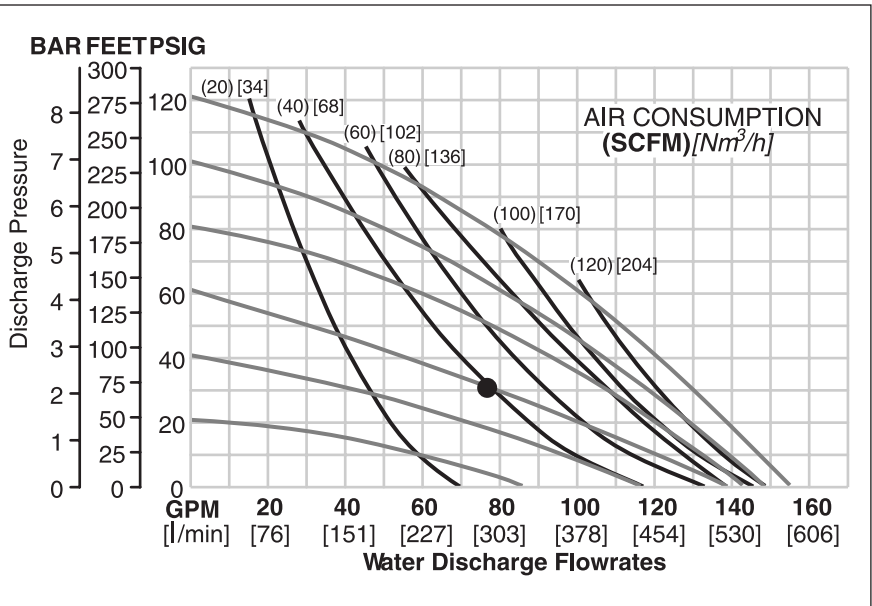

Flow rates indicated on chart were determined by pumping water.

For optimum life and performance, pumps should be specified so that daily operation parameters will fall in the center of the pump performance curve.

## SECTION 5B

# PERFORMANCE CURVES

## MODEL P8 PLASTIC ULTRA-FLEX™-FITTED

Height.....77.0 cm (30<sup>5</sup>/<sub>16</sub>" )  
 Width.....49.1 cm (19<sup>1</sup>/<sub>2</sub>" )  
 Depth.....33.2 cm (13<sup>3</sup>/<sub>2</sub>" )  
 Ship Weight..Polypropylene 33.8 kg (74.6 lbs.)  
                   PVDF 42.9 kg (94.6 lbs.)  
 Air Inlet.....1.27 cm (1/2" )  
 Inlet .....5.08 cm (2" )  
 Outlet .....5.08 cm (2" )  
 Suction Lift .....4.88 m Dry (16' )  
                   8.84 m Wet (29' )

Displacement per  
 Stroke ..... 2.12 l (.56 gal.)<sup>1</sup>  
 Max. Flow Rate.....560.2 l/m (148 gpm)  
 Max. Size Solids.....6.35 mm (1/4" )  
<sup>1</sup>Displacement per stroke was calculated at 4.8 Bar (70 psig) air inlet pressure against a 2 Bar (30 psig) head pressure.

**Example:** To pump 257.4 lpm (68 gpm) against a discharge pressure head of 2.0 Bar (30 psig) requires 4.1 Bar (60 psig) and 76.5 Nm<sup>3</sup>/h (45 scfm) air consumption. (See dot on chart.)

**Caution: Do not exceed 8.6 Bar (125 psig) air supply pressure.**

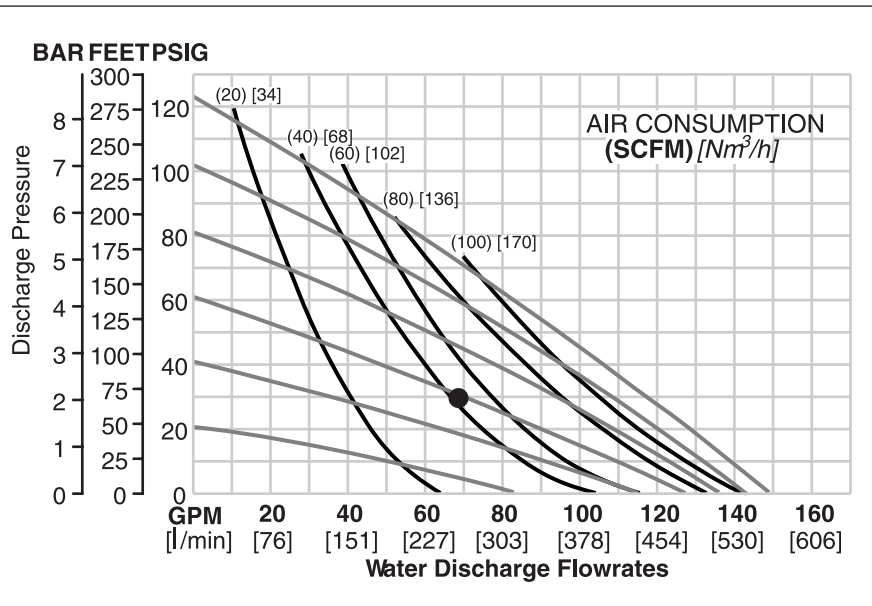

Flow rates indicated on chart were determined by pumping water.

For optimum life and performance, pumps should be specified so that daily operation parameters will fall in the center of the pump performance curve.

## SECTION 5C

# PERFORMANCE CURVES

## MODEL P8 PLASTIC TPE-FITTED

Height.....77.0 cm (30<sup>3</sup>/<sub>16</sub>"")  
 Width.....49.1 cm (19<sup>1</sup>/<sub>32</sub>"")  
 Depth.....33.2 cm (13<sup>3</sup>/<sub>32</sub>"")  
 Ship Weight..Polypropylene 33.8 kg (74.6 lbs.)  
                   PVDF 42.9 kg (94.6 lbs.)  
 Air Inlet.....1.27 cm (1/2")  
 Inlet.....5.08 cm (2")  
 Outlet.....5.08 cm (2")  
 Suction Lift .....5.18 m Dry (17')  
                   9.45 m Wet (31')

Displacement per  
 Stroke.....2.91 l (.77 gal.)<sup>1</sup>  
 Max. Flow Rate.....575.4 l/m (152 gpm)  
 Max. Size Solids.....6.35 mm (1/4")  
<sup>1</sup>Displacement per stroke was calculated at 4.8 Bar (70 psig) air inlet pressure against a 2 Bar (30 psig) head pressure.

**Example:** To pump 283.9 lpm (75 gpm) against a discharge pressure head of 2.1 Bar (30 psig) requires 4.1 Bar (60 psig) and 76.5 Nm<sup>3</sup>/h (45 scfm) air consumption. (See dot on chart.)

**Caution: Do not exceed 8.6 Bar (125 psig) air supply pressure.**

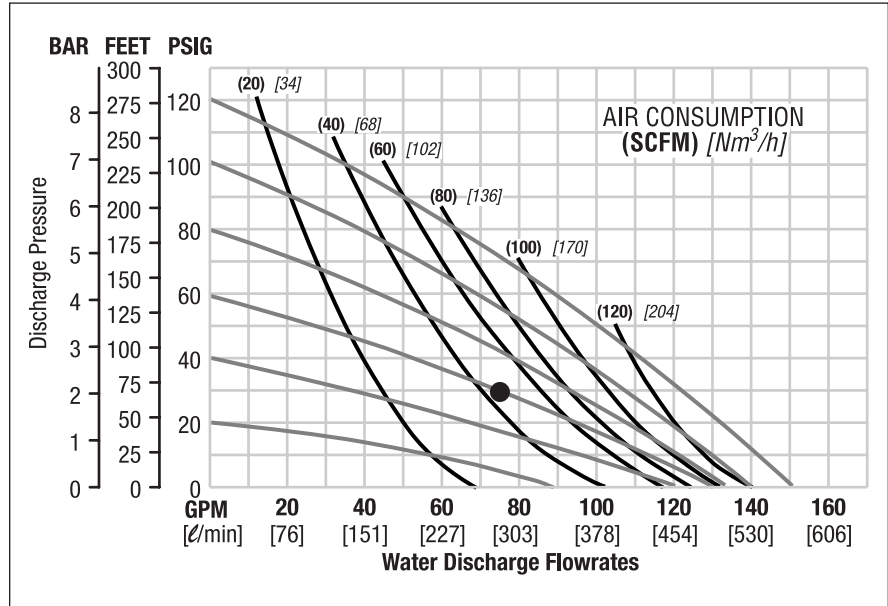

Flow rates indicated on chart were determined by pumping water.

For optimum life and performance, pumps should be specified so that daily operation parameters will fall in the center of the pump performance curve.

## SECTION 5D

# PERFORMANCE CURVES

## MODEL P8 PLASTIC TEFLON®-FITTED

Height.....77.0 cm (30<sup>3</sup>/<sub>16</sub>"")  
 Width.....49.1 cm (19<sup>1</sup>/<sub>32</sub>"")  
 Depth.....33.2 cm (13<sup>3</sup>/<sub>32</sub>"")  
 Ship Weight..Polypropylene 33.8 kg (74.6 lbs.)  
                   PVDF 42.9 kg (94.6 lbs.)  
 Air Inlet.....1.27 cm (1/2")  
 Inlet.....5.08 cm (2")  
 Outlet.....5.08 cm (2")  
 Suction Lift .....4.27 m Dry (14')  
                   9.45 m Wet (31')

Displacement per  
 Stroke ..... .53 l gal. (.47)<sup>1</sup>  
 Max. Flow Rate.....260.8 l/m (127 gpm)  
 Max. Size Solids.....6.35 mm (1/4")  
<sup>1</sup>Displacement per stroke was calculated at 4.8 Bar (70 psig) air inlet pressure against a 2 Bar (30 psig) head pressure.

**Example:** To pump 238.5 lpm (63 gpm) against a discharge pressure head of 2.0 Bar (30 psig) requires 4.1 Bar (60 psig) and 45 Nm<sup>3</sup>/h (55 scfm) air consumption. (See dot on chart.)

**Caution: Do not exceed 8.6 Bar (125 psig) air supply pressure.**

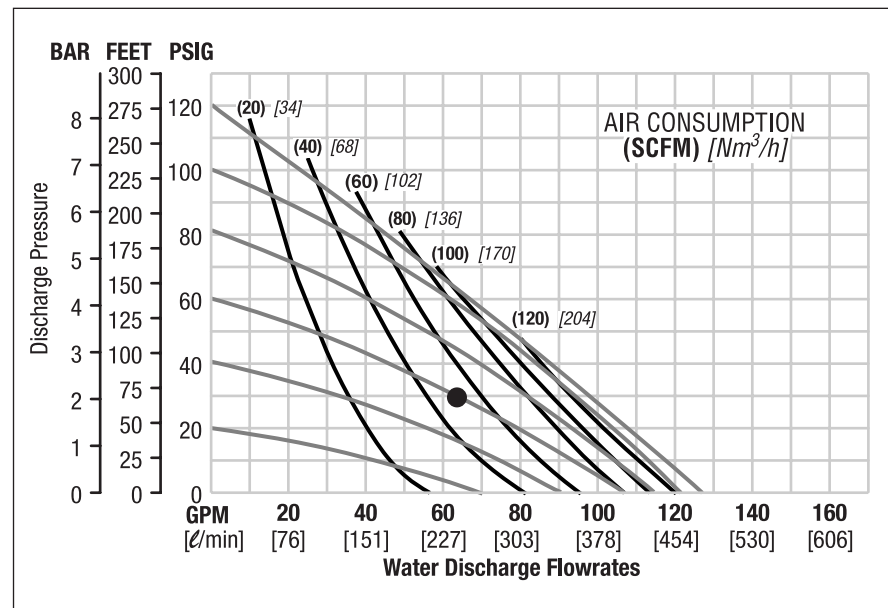

Flow rates indicated on chart were determined by pumping water.

For optimum life and performance, pumps should be specified so that daily operation parameters will fall in the center of the pump performance curve.



## SECTION 6

# SUCTION LIFT CURVES & DATA

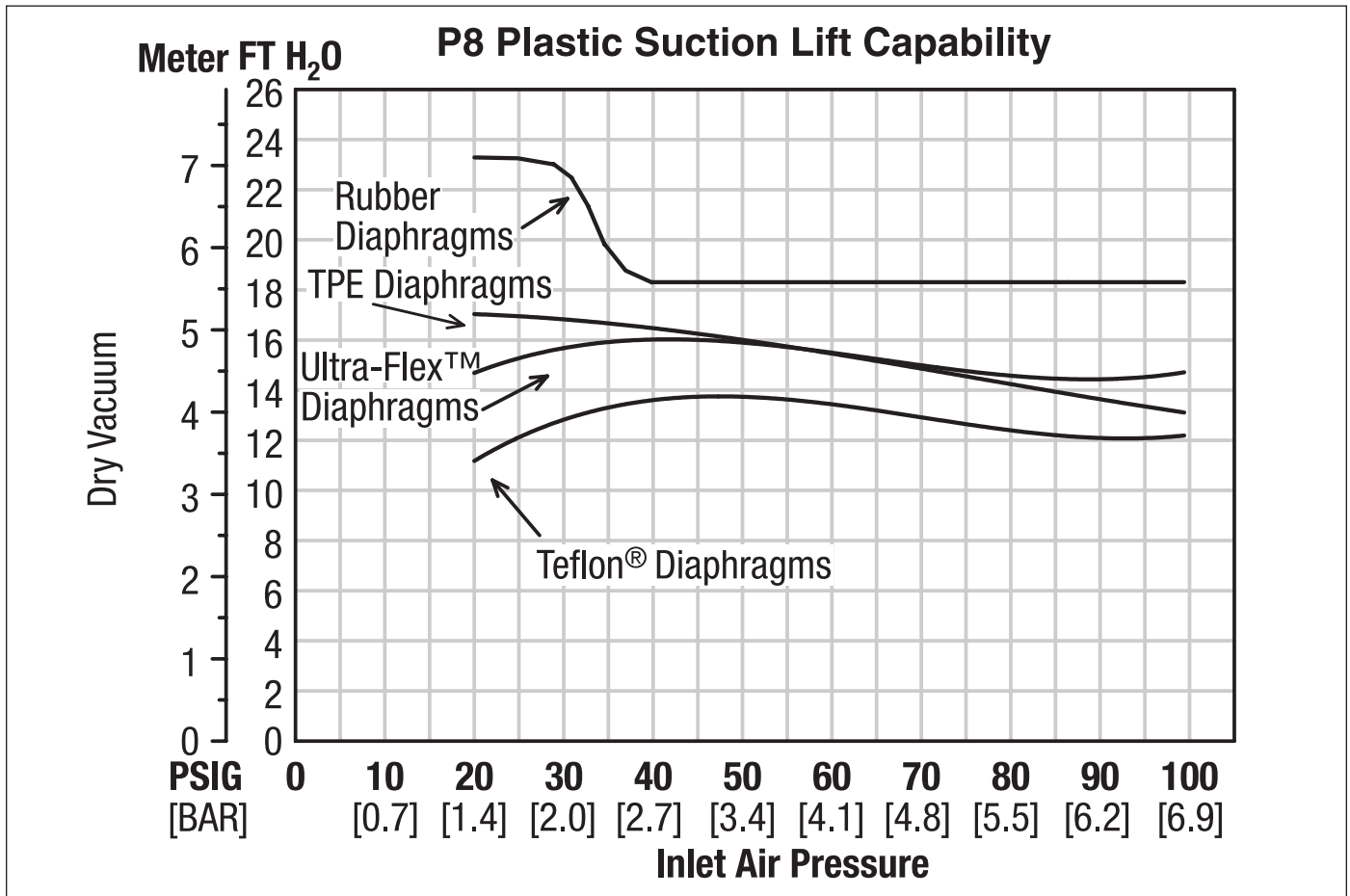

Suction lift curves are calibrated for pumps operating at 305 m (1,000') above sea level. This chart is meant to be a guide only. There are many variables which can affect your pump's operating characteristics. The number of intake and discharge elbows,

viscosity of pumping fluid, elevation (atmospheric pressure) and pipe friction loss all affect the amount of suction lift your pump will attain.

# SECTION 7A – AIR OPERATION

## INSTALLATION

---

The Pro-Flo™ model P8 has a 5.08 cm (2") inlet and 5.08 cm (2") outlet and is designed for flows to 586.7 lpm (155 gpm). The **P8 Plastic** pump is manufactured with wetted parts of pure, unpigmented PVDF or polypropylene. The center block of the **P8 Plastic** is constructed of virgin polypropylene. A variety of diaphragms and O-rings are available to satisfy temperature, chemical compatibility, abrasion and flex concerns.

The suction pipe size should be at least 5.08 cm (2") diameter or larger if highly viscous material is being pumped. The suction hose must be non-collapsible, reinforced type as the P8 is capable of pulling a high vacuum. Discharge piping should be at least 5.08 cm (2"); larger diameter can be used to reduce friction losses. It is critical that all fittings and connections are airtight or a reduction or loss of pump suction capability will result.

For **P8 Plastic** models, Wilden offers 150 lb. flanges. The following details should be noted when mating these to pipe works:

- A 60–80 shore gasket that covers the entire flange face should be used.
- The gasket should be between 1.91 mm (.075") and 4.45 mm (.175") thickness.
- Mating flanges with flat as opposed to raised surfaces should be used for proper mechanical sealing.
- The flanges should be tightened to a minimum of 6.8 m-N (5 ft.-lbs.) but no more than 13.5 m-N (10 ft.-lbs.).

**INSTALLATION:** Months of careful planning, study, and selection efforts can result in unsatisfactory pump performance if installation details are left to chance.

Premature failure and long term dissatisfaction can be avoided if reasonable care is exercised throughout the installation process.

**LOCATION:** Noise, safety, and other logistical factors usually dictate where equipment be situated on the production floor. Multiple installations with conflicting requirements can result in congestion of utility areas, leaving few choices for additional pumps.

Within the framework of these and other existing conditions, every pump should be located in such a way that five key factors are balanced against each other to maximum advantage.

**ACCESS:** First of all, the location should be accessible. If it's easy to reach the pump, maintenance personnel will have an easier time carrying out routine inspections and adjustments. Should major repairs become necessary, ease of access can play a key role in speeding the repair process and reducing total downtime.

**AIR SUPPLY:** Every pump location should have an air line large enough to supply the volume of air necessary to achieve the desired pumping rate (see Section 5). Use air pressure up to a maximum of 8.6 Bar (125 psi) depending on pumping requirements.

For best results, the pumps should use a 5 micron air filter, needle valve and regulator. The use of an air filter before the pump will ensure that the majority of any pipeline contaminants will be eliminated.

**SOLENOID OPERATION:** When operation is controlled by a solenoid valve in the air line, three-way valves should be used, thus allowing trapped air to bleed off and improving pump

performance. Pumping volume can be set by counting the number of strokes per minute and multiplying by displacement per stroke.

Sound levels are reduced below OSHA specifications using the standard Wilden muffler. Other mufflers can be used but usually reduce pump performance.

**ELEVATION:** Selecting a site that is well within the pump's dynamic lift capability will assure that loss-of-prime troubles will be eliminated. In addition, pump efficiency can be adversely affected if proper attention is not given to site location.

**PIPING:** Final determination of the pump site should not be made until the piping problems of each possible location have been evaluated. The impact of current and future installations should be considered ahead of time to make sure that inadvertent restrictions are not created for any remaining sites.

The best choice possible will be a site involving the shortest and straightest hook-up of suction and discharge piping. Unnecessary elbows, bends, and fittings should be avoided. Pipe sizes should be selected so as to keep friction losses within practical limits. All piping should be supported independently of the pump. In addition, the piping should be aligned so as to avoid placing stresses on the pump fittings.

Flexible hose can be installed to aid in absorbing the forces created by the natural reciprocating action of the pump. If the pump is to be bolted down to a solid location, a mounting pad placed between the pump and the foundation will assist in minimizing pump vibration. Flexible connections between the pump and rigid piping will also assist in minimizing pump vibration. If quick-closing valves are installed at any point in the discharge system, or if pulsation within a system becomes a problem, a surge suppressor should be installed to protect the pump, piping and gauges from surges and water hammer.

When pumps are installed in applications involving flooded suction or suction head pressures, a gate valve should be installed in the suction line to permit closing of the line for pump service.

For **P8 Plastic** models, a non-raised surfaced-flange adapter should be utilized when mating to the pump's inlet and discharge manifolds for proper sealing.

The P8 cannot be used in submersible applications.

If the pump is to be used in a self-priming application, be sure that all connections are airtight and that the suction lift is within the model's ability. Note: Materials of construction and elastomer material have an effect on suction lift parameters. Please consult Wilden distributors for specifics.

Pumps in service with a positive suction head are most efficient when inlet pressure is limited to .5–.7 Bar (7–10 psig). Premature diaphragm failure may occur if positive suction is 10 psig and higher.

**THE MODEL P8 CHAMP WILL PASS 6.35 MM (¼") SOLIDS. WHENEVER THE POSSIBILITY EXISTS THAT LARGER SOLID OBJECTS MAY BE SUCKED INTO THE PUMP, A STRAINER SHOULD BE USED ON THE SUCTION LINE.**

**CAUTION: DO NOT EXCEED 8.6 BAR (125 PSIG) AIR SUPPLY PRESSURE.**

**P8 PUMPS CANNOT BE SUBMERGED. FOR SUBMERGED APPLICATIONS, USE A WILDEN T8 PUMP.**

# SUGGESTED INSTALLATION

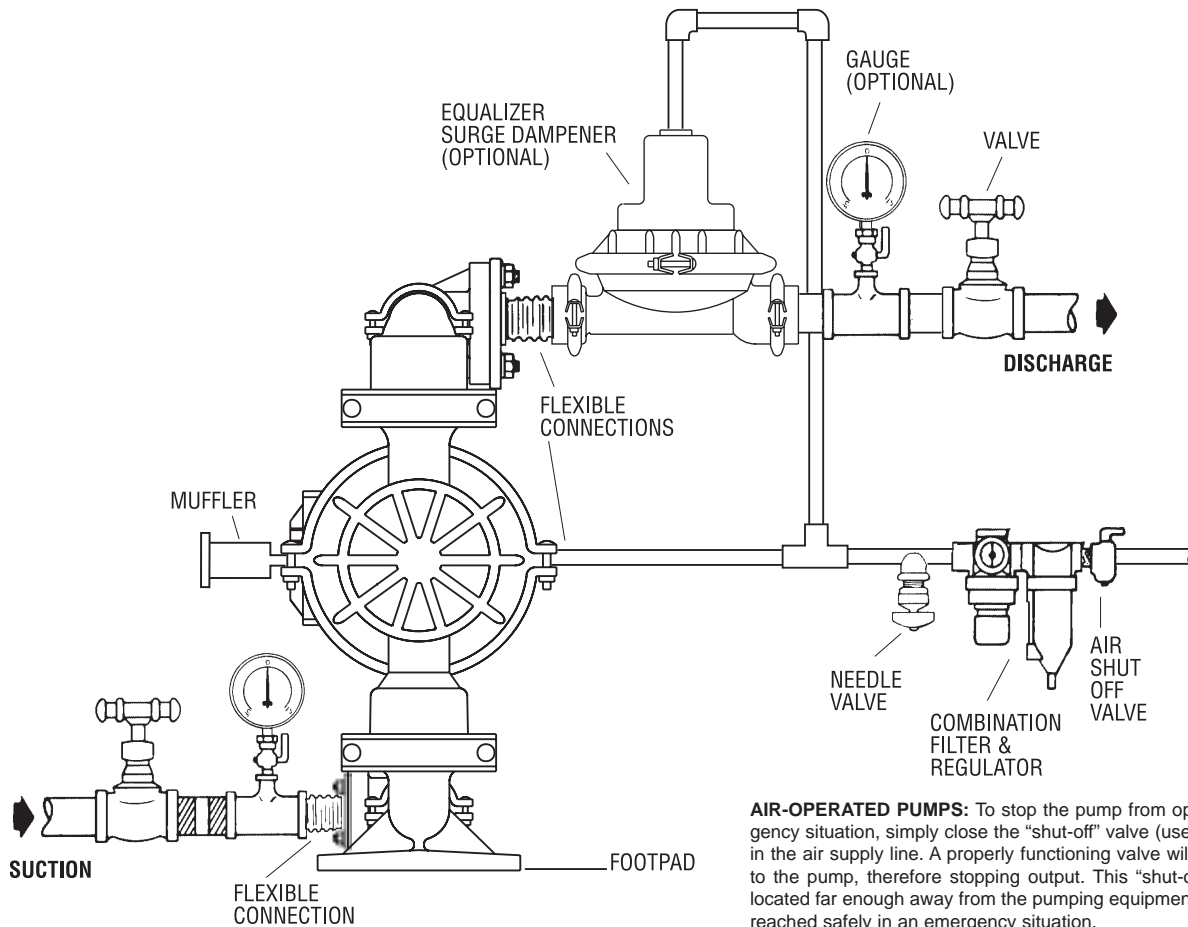

**AIR-OPERATED PUMPS:** To stop the pump from operating in an emergency situation, simply close the "shut-off" valve (user supplied) installed in the air supply line. A properly functioning valve will stop the air supply to the pump, therefore stopping output. This "shut-off" valve should be located far enough away from the pumping equipment such that it can be reached safely in an emergency situation.

**NOTE:** In the event of a power failure, the shutoff valve should be closed, if the restarting of the pump is not desirable once power is regained.

## SECTION 7B – AIR OPERATION

# SUGGESTED OPERATION AND MAINTENANCE INSTRUCTIONS

**OPERATION:** The P8 is pre-lubricated, and does not require in-line lubrication. Additional lubrication will not damage the pump, however if the pump is heavily lubricated by an external source, the pump's internal lubrication may be washed away. If the pump is then moved to a non-lubricated location, it may need to be disassembled and re-lubricated as described in the ASSEMBLY/DISASSEMBLY INSTRUCTIONS.

Pump discharge rate can be controlled by limiting the volume and/or pressure of the air supply to the pump (preferred method). An air regulator is used to regulate air pressure. A needle valve is used to regulate volume. Pump discharge rate can also be controlled by throttling the pump discharge by partially closing a valve in the discharge line of the pump. This action increases friction loss which reduces flow rate. (See Section 5.) This is useful when the need exists to control the pump from a remote location. When the pump discharge pressure equals or exceeds the air supply pressure, the pump will stop; no bypass or pressure relief valve is needed, and pump damage will not occur. The pump has reached a "deadhead" situation and can be restarted by reducing the fluid discharge

pressure or increasing the air inlet pressure. The Wilden P8 pump runs solely on compressed air and does not generate heat, therefore your process fluid temperature will not be affected.

**MAINTENANCE AND INSPECTIONS:** Since each application is unique, maintenance schedules may be different for every pump. Frequency of use, line pressure, viscosity and abrasiveness of process fluid all affect the parts life of a Wilden pump. Periodic inspections have been found to offer the best means for preventing unscheduled pump downtime. Personnel familiar with the pump's construction and service should be informed of any abnormalities that are detected during operation.

**RECORDS:** When service is required, a record should be made of all necessary repairs and replacements. Over a period of time, such records can become a valuable tool for predicting and preventing future maintenance problems and unscheduled downtime. In addition, accurate records make it possible to identify pumps that are poorly suited to their applications.

# **SECTION 7C – AIR OPERATION**

## **TROUBLESHOOTING**

---

### ***Pump will not run or runs slowly.***

1. Ensure that the air inlet pressure is at least .35 Bar (5 psig) above startup pressure and that the differential pressure (the difference between air inlet and liquid discharge pressures) is not less than .7 Bar (10 psig).
2. Check air inlet filter for debris (see recommended installation).
3. Check for extreme air leakage (blow by) which would indicate worn seals/bores in the air valve, pilot spool and main shaft.
4. Disassemble pump and check for obstructions in the air passageways or objects which would obstruct the movement of internal parts.
5. Check for sticking ball check valves. If material being pumped is not compatible with pump elastomers, swelling may occur. Replace ball check valves and seals with proper elastomers. Also, as the check valve balls wear out, they become smaller and can become stuck in the seats. In this case, replace balls and seats.
6. Check for broken inner piston which will cause the air valve spool to be unable to shift.
7. Remove plug from pilot spool exhaust.

### ***Pump runs but little or no product flows.***

1. Check for pump cavitation; slow pump speed down to allow thick material to flow into the liquid chambers.

2. Verify that vacuum required to lift liquid is not greater than the vapor pressure of the material being pumped (cavitation).
3. Check for sticking ball check valves. If material being pumped is not compatible with pump elastomers, swelling may occur. Replace ball check valves and seals with proper elastomers. Also, as the check valve balls wear out, they become smaller and can become stuck in the seats. In this case, replace balls and seats.

### ***Pump air valve freezes.***

1. Check for excessive moisture in compressed air. Either install a dryer or hot air generator for compressed air. Alternatively, a coalescing filter may be used to remove the water from the compressed air in some applications.

### ***Air bubbles in pump discharge.***

1. Check for ruptured diaphragm.
2. Check tightness of outer pistons. (Refer to Section 8C.)
3. Check tightness of clamp bands and integrity of O-rings and seals, especially at intake manifold.
4. Ensure pipe connections are airtight.

### ***Product comes out air exhaust.***

1. Check for diaphragm rupture.
2. Check tightness of outer pistons to shaft.

## SECTION 8A

# MODEL P8 PLASTIC DIRECTIONS FOR DISASSEMBLY/REASSEMBLY

**CAUTION:** Before any maintenance or repair is attempted, the compressed air line to the pump should be disconnected and all air pressure allowed to bleed from the pump. Disconnect all intake, discharge, and air lines. Drain the pump by turning it upside down and allowing any fluid to flow into a suitable container. Be aware of any hazardous effects of contact with your process fluid.

The Wilden P8 has a 5.08 cm (2") inlet and outlet and is designed for flows up to 586.7 LPM (155 GPM). Its air distribution system is based on a revolutionary design which increases reliability and performance. The model P8 is available in injection molded polypropylene and PVDF wetted parts.

### TOOLS REQUIRED:

½" Wrench

⅞" Wrench

Adjustable Wrench

Vise equipped with soft jaws (such as plywood, plastic or other suitable material)

**NOTE:** The model used for these instructions incorporates rubber diaphragms, balls, and seats. Models with Teflon® diaphragms, balls and seats are the same except where noted.

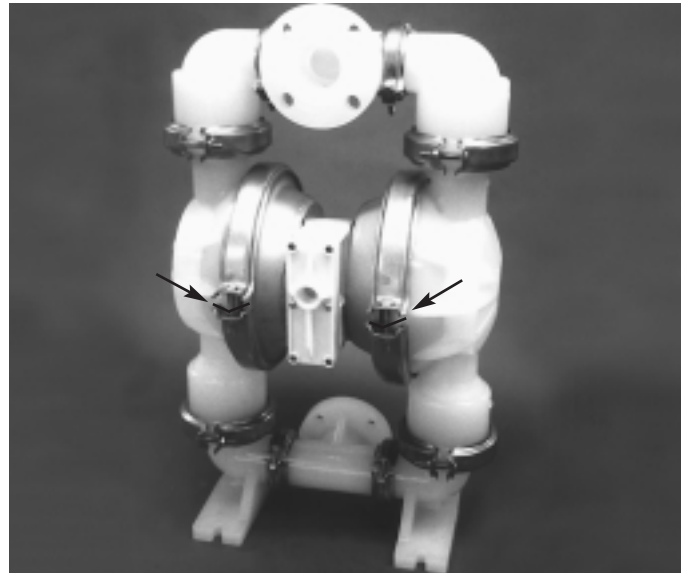

### DISASSEMBLY:

Figure 1

#### Step 1.

Before starting disassembly, mark a line from each liquid chamber to its corresponding air chamber. This line will assist in proper alignment during reassembly. (Figure 1)



#### Step 2.

Figure 2

Utilizing a ½" wrench, remove the two small clamp bands that fasten the discharge manifold to the liquid chambers. (Figure 2)

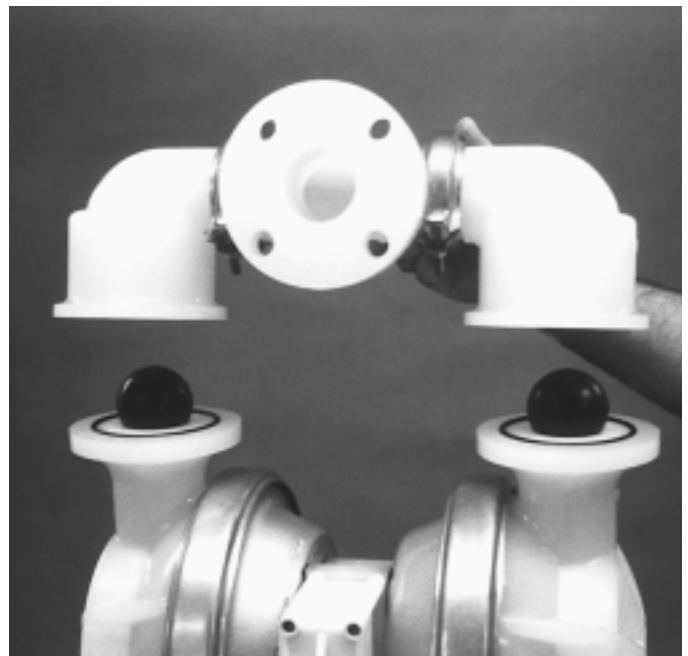

#### Step 3.

Figure 3

Remove the discharge manifold to expose the valve balls and seats. Inspect ball cage area of manifold for excessive wear or damage. (Figure 3)





**Step 4.** *Figure 4*

Remove the discharge valve balls and seats (*Figure 4*) from the liquid chambers and inspect for nicks, gouges, chemical attack or abrasive wear. Replace worn parts with genuine Wilden parts for reliable performance.



**Step 5.** *Figure 5*

Remove the two small clamp bands which fasten the intake manifold to the liquid chambers. (*Figure 5*)



**Step 6.** *Figure 6*

Lift intake manifold from liquid chambers and center section to expose intake valve balls and seats. Inspect ball cage area of liquid chambers for excessive wear or damage. (*Figure 6*)

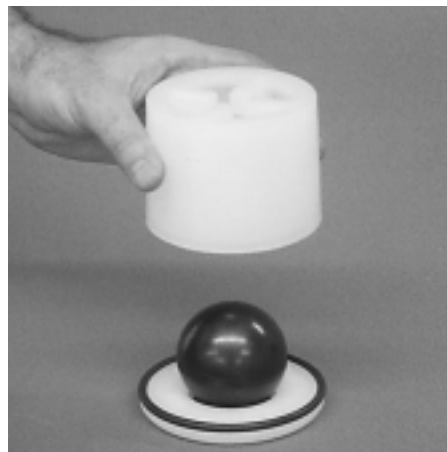

**Step 7.** *Figure 7*

Inspect ball guide bushing, ball, seat and O-ring for nicks, gouges, chemical attack or abrasive wear. Replace worn parts with genuine Wilden parts for reliable performance. (*Figure 7*)

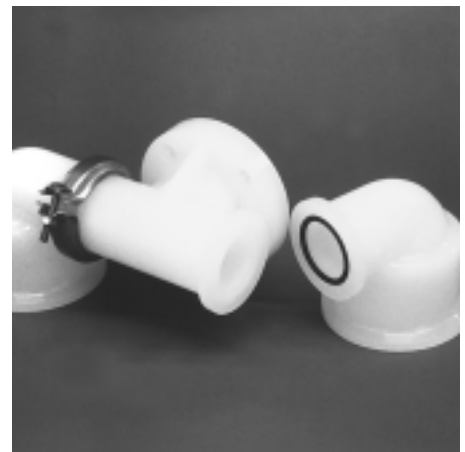

**Step 8.** *Figure 8*

Remove small manifold clamp bands to inspect manifold O-rings. (*Figure 8*)





**Step 9.** *Figure 9*  
Remove one set of large clamp bands which secure one liquid chamber to the center section. (*Figure 9*)



**Step 10.** *Figure 10*  
Lift liquid chamber away from center section to expose diaphragm and outer piston. (*Figure 10*)



**Step 11.** *Figure 11*  
Using an adjustable wrench, or by rotating the diaphragm by hand, remove the diaphragm assembly. (*Figure 11*)



**Step 12.** *Figure 12*



*Figure 13*

**NOTE:** Due to varying torque values, one of the following two situations may occur: 1) The outer piston, diaphragm and inner piston remain attached to the shaft and the entire assembly can be removed from the center section (*Figure 12*). 2) The outer piston, diaphragm and inner piston separate from the shaft which remains connected to the opposite side diaphragm assembly (*Figure 13*). Repeat disassembly instructions for the opposite liquid chamber. Inspect diaphragm assembly and shaft for signs of wear or chemical attack. Replace all worn parts with genuine Wilden parts for reliable performance.



**Step 13.** *Figure 14*

To remove diaphragm assembly from shaft, secure shaft with soft jaws (a vise fitted with plywood, plastic or other suitable material) to ensure shaft is not nicked, scratched or gouged. Using an adjustable wrench or by hand, remove diaphragm assembly from shaft. (*Figure 14*)

## SECTION 8B

# PRO-FLO™ AIR VALVE/CENTER SECTION DISASSEMBLY, CLEANING, INSPECTION

### AIR VALVE DISASSEMBLY:

**CAUTION:** Before any maintenance or repair is attempted, the compressed air line to the pump should be disconnected and all air pressure allowed to bleed from the pump. Disconnect all intake, discharge, and air lines. Drain the pump by turning it upside down and allowing any fluid to flow into a suitable container. Be aware of hazardous effects of contact with your process fluid.

The Wilden Plastic P8 utilizes a revolutionary Pro-Flo™ air distribution system. A 1.27 cm (½") air inlet connects the air supply to the center section. Proprietary composite seals reduce the coefficient of friction and allow the P8 to run lube-free. Constructed of Acetal, the Pro-Flo™ air distribution system is designed to perform in on/off, non-freezing, non-stalling, tough duty applications.

### TOOLS REQUIRED:

⅜" Hex Head Wrench  
½" Hex Head Wrench  
Snap Ring Pliers  
Phillips Head Screwdriver  
O-Ring Pick

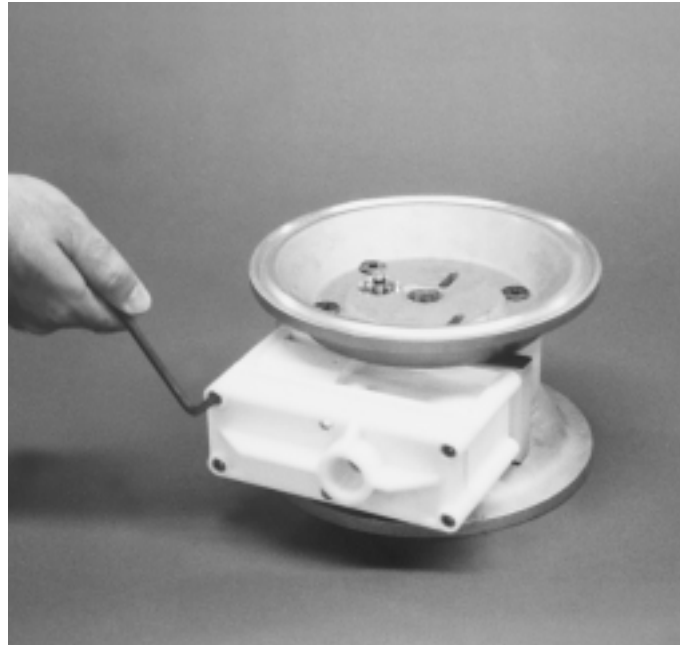

**Step 1.**

*Figure 1*

Loosen the air valve bolts utilizing a ⅜" hex head wrench and then remove muffer plate screws with a Phillips head screwdriver. (*Figure 1*)

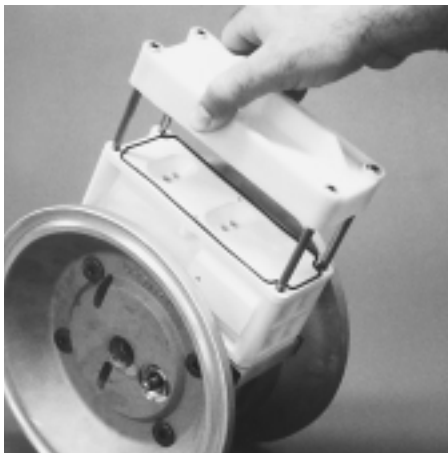

**Step 2.**

*Figure 2*

Remove muffer plate and air valve bolts from air valve assembly (*Figure 2*) exposing muffer gasket for inspection. Replace if necessary.



**Step 3.**

*Figure 3*

Lift away air valve assembly and remove air valve gasket for inspection (*Figure 3*). Replace if necessary.



**Step 4.**

*Figure 4*

Remove air valve end cap to expose air valve spool by simply lifting up on end cap once air valve bolts are removed. (*Figure 4*).

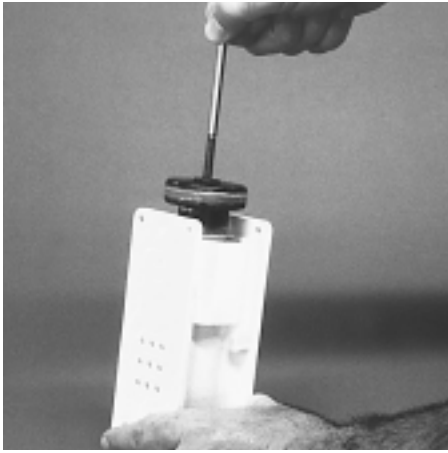

**Step 5.** *Figure 5*

Remove air valve spool from air valve body by threading one air valve bolt into the end of the spool and gently sliding the spool out of the air valve body (*Figure 5*). Inspect seals for signs of wear and replace entire assembly if necessary. Use caution when handling air valve spool to prevent damaging seals.

**NOTE:** Seals should not be removed from assembly.  
Seals are not sold separately.

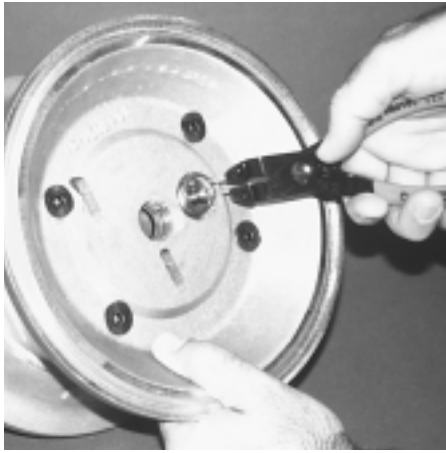

**Step 6.** *Figure 6*

Remove pilot spool retaining snap ring on both sides of center section with snap ring pliers (*Figure 6*).



**Step 7.** *Figure 7*

Remove air chamber bolts with  $\frac{7}{32}$ " hex head wrench (*Figure 7*).

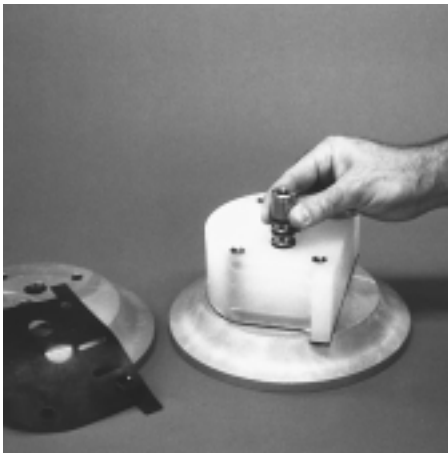

**Step 8.** *Figure 8*

Remove pilot spool bushing from center block (*Figure 8*).



**Step 9.** *Figure 9*

With O-ring pick, gently remove pilot spool retaining O-ring (*Figure 9*). Replace if necessary. Gently remove pilot spool from bushing and inspect spool and seals for nicks, gouges or other signs of wear. Replace pilot sleeve assembly or outer bushing O-rings if necessary.

**NOTE:** Seals should not be removed from pilot spool.  
Seals are not sold separately.

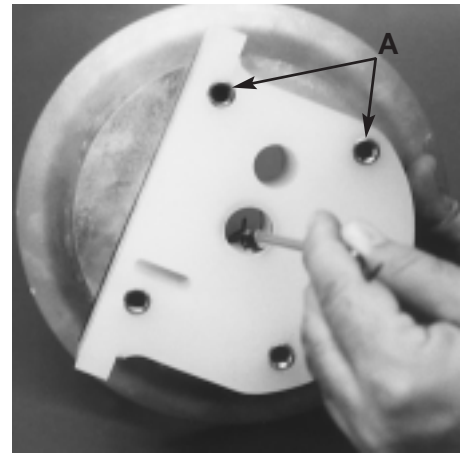

**Step 10.** *Figure 10*

Check center block glyd rings for signs of wear. If necessary, remove glyd rings with O-ring pick and replace. (*Figure 10*)

**NOTE:** Threaded sleeves (see A — *Figure 10*) are removable and can be replaced if necessary. Sleeves can be press fit by hand.

## SECTION 8C

# REASSEMBLY HINTS & TIPS

### ASSEMBLY:

Upon performing applicable maintenance to the air distribution system, the pump can now be reassembled. Please refer to the disassembly instructions for photos and parts placement. To reassemble the pump, follow the disassembly instructions in reverse order. The air distribution system needs to be assembled first, then the diaphragms and finally the wetted path. Please find the applicable torque specifications on this page. The following tips will assist in the assembly process.

- Lubricate air valve bore, center section shaft and pilot spool bore with NLGI grade 2 molybdenum disulfide based grease or equivalent.
- Clean the inside of the center section shaft bushing to ensure no damage is done to new glyd ring seals.
- A small amount NLGI grade 2 molybdenum disulfide based grease can be applied to the muffler and air valve gaskets to locate gaskets during assembly.
- Make sure that the exhaust port on the muffler plate is centered between the two exhaust ports on the center section.
- Stainless bolts should be lubed to reduce the possibility of seizing during tightening.
- Use a mallet to tamp lightly on the large clamp bands to seat the diaphragm before tightening.

### MAXIMUM TORQUE SPECIFICATIONS

Description of Part	Plastic Pumps
Air Valve	5 m-N [45 in.-lbs.]
Outer Piston (Traditional)	78.6 m-N [58 ft.-lbs.]
Outer Piston (Ultra-Flex™)	51.5 m-N [38 ft.-lbs.]
Small Clamp Band	9.6 m-N [85 in.-lbs.]
Large Clamp Band (Rubber-Fitted)	18.6 m-N [165 in.-lbs.]
Large Clamp Band (Teflon®-Fitted)	18.6 m-N [165 in.-lbs.]
Air Chamber Screws	47.4 m-N [35 ft.-lbs.]

### GLYD RING INSTALLATION:

#### PRE-INSTALLATION

- Once all of the old seals have been removed, the inside of the bushing should be cleaned to ensure no debris is left that may cause premature damage to the new seals.

#### INSTALLATION

The following tools can be used to aid in the installation of the new seals:

Needle Nose Pliers  
Phillips Screwdriver  
Electrical Tape

- Wrap electrical tape around each leg of the needle nose pliers (heat shrink tubing may also be used). This is done to prevent damaging the inside surface of the new seal.
- With a new seal in hand, place the two legs of the needle nose pliers inside the seal ring. (See *Figure A*.)
- Open the pliers as wide as the seal diameter will allow, then with two fingers pull down on the top portion of the seal to form kidney bean shape. (See *Figure B*.)
- Lightly clamp the pliers together to hold the seal into the kidney shape. Be sure to pull the seal into as tight of a kidney shape as possible, this will allow the seal to travel down the bushing bore easier.
- With the seal clamped in the pliers, insert the seal into the bushing bore and position the bottom of the seal into the correct groove. Once the bottom of the seal is seated in the groove, release the clamp pressure on the pliers. This will allow the seal to partially snap back to its original shape.
- After the pliers are removed, you will notice a slight bump in the seal shape. Before the seal can be properly resized, the bump in the seal should be removed as much as possible. This can be done with either the Phillips screwdriver or your finger. With either the side of the screwdriver or your finger, apply light pressure to the peak of the bump. This pressure will cause the bump to be almost completely eliminated.
- Lubricate the edge of the shaft with NLGI grade 2 molybdenum disulfide based grease.
- Slowly insert the center shaft with a rotating motion. This will complete the resizing of the seal.
- Perform these steps for the remaining seal.

Figure A

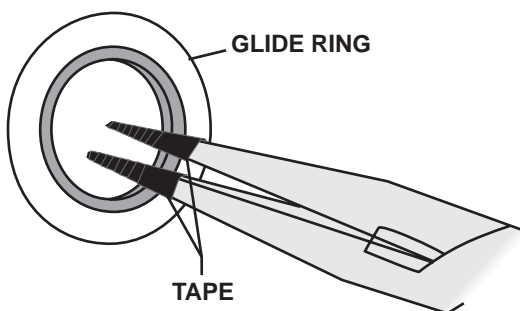
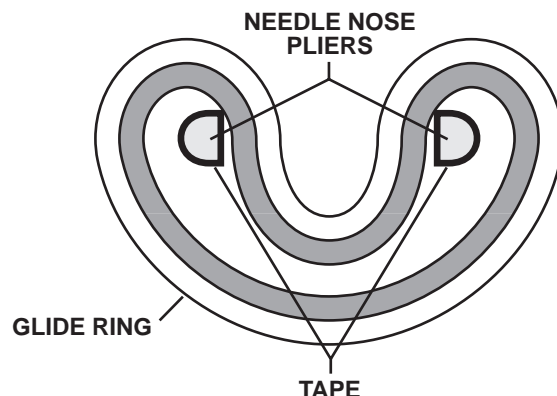

Figure B





# GASKET KIT INSTALLATION

Only P8 PVDF pumps come standard with expanded Teflon® Gasket Kits (P/N 08-9501-99) and P8 polypropylene pumps come with kits for liquid chambers only (P/N 08-9500-99). Carefully prepare sealing surfaces by removing all debris and foreign

matter from diaphragm bead and all mating surfaces. If necessary, smooth or deburr all sealing surfaces. Mating surfaces must be properly aligned in order to ensure positive sealing characteristics.

## PVDF AND POLYPROPYLENE



**Step 1.** *Figure 1*

Gently remove the adhesive covering from the back of the Teflon® tape. Ensure that the adhesive strip remains attached to the Teflon® tape.



**Step 2.** *Figure 2*

Starting at any point, place the Teflon® tape in the center of the diaphragm bead groove on the liquid chamber and press lightly on the tape to ensure that the adhesive holds it in place during assembly. Do not stretch the tape during placement in center of diaphragm bead groove.



**Step 3.** *Figure 3*

The ends of the tape should overlap approximately 1.27 cm ( $\frac{1}{2}$ " ) (*Figure 3*). Proceed to install the Teflon® tape on the remaining liquid chamber.

## PVDF

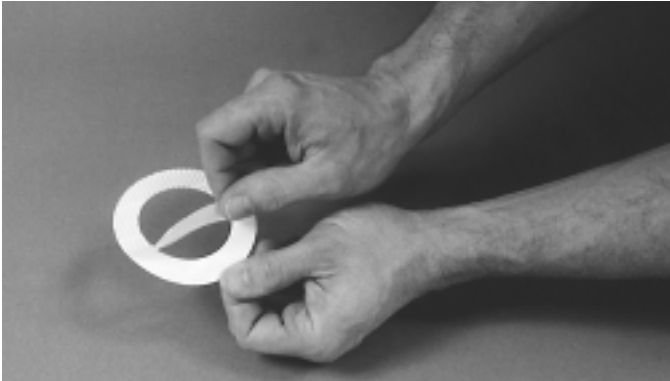

**Step 4.** *Figure 4*

Carefully remove the protective covering from the back of the Teflon® gasket attached to tape. (*Figure 4*)



**Step 5.** *Figure 5*

Install the valve ball, valve seat and O-ring. (*Figure 5*)



**Step 6.** *Figure 6*

Center the gasket so that it evenly covers the O-ring and seat areas. (*Figure 6*)



**Step 7.** *Figure 7*

Gently apply pressure to gasket to ensure the adhesive maintains a positive seal to stay in place during pump assembly. (*Figure 7*)

# SECTION 9A

# EXPLODED VIEW/PARTS LISTING

# P8

PLASTIC  
RUBBER/TPE/  
ULTRA-FLEX™.  
FITTED

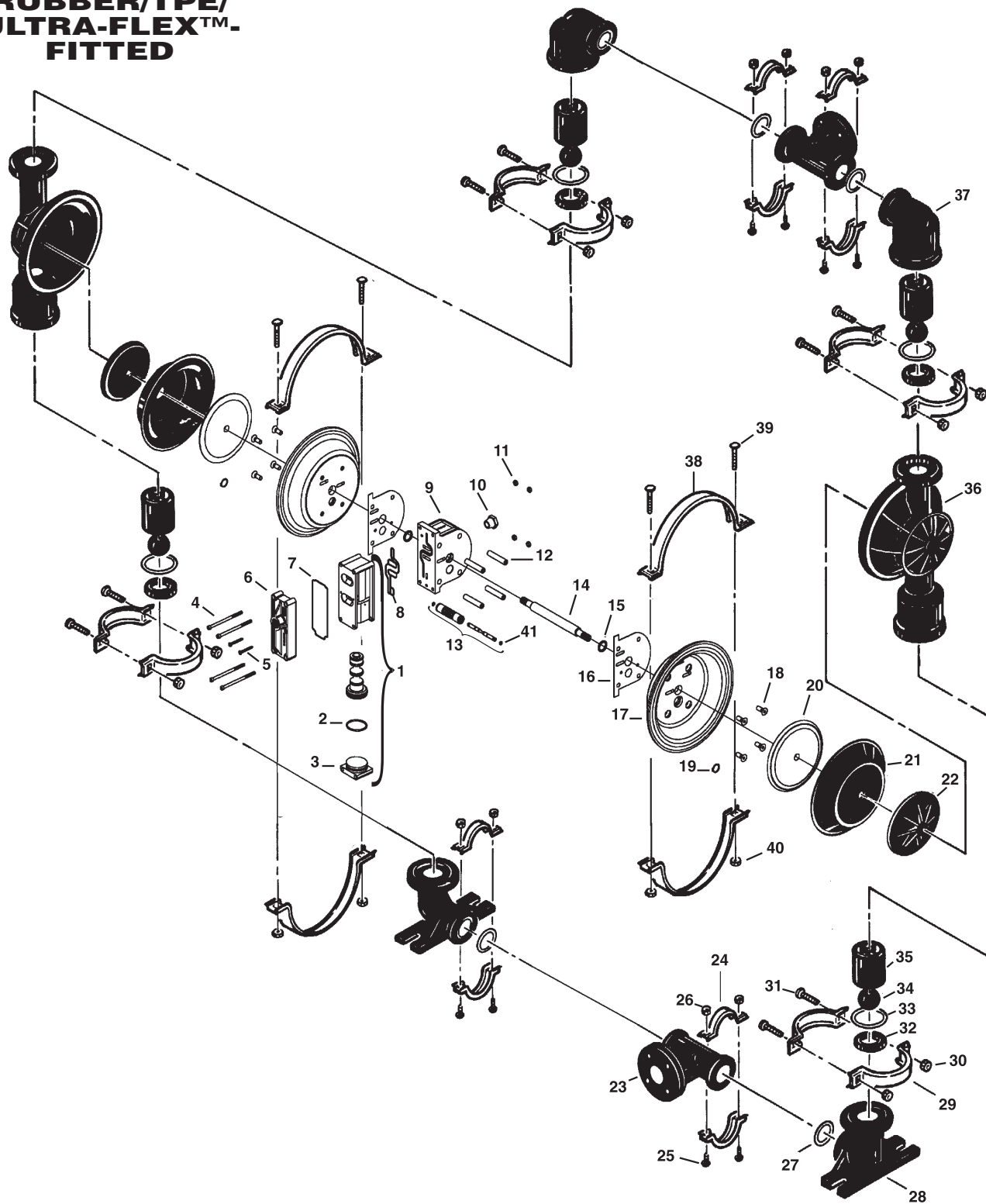



## P8 Plastic, Rubber/TPE-Fitted or Ultra-Flex™-Fitted

Item #	Part Description	Qty. per Pump	P8/PAPP P/N	P8/KAPP P/N	P8/PAPP-502 P/N	P8/KAPP-502 P/N
1	Pro-Flo® Air Valve Assembly¹	1	04-2000-20-700	04-2000-20-700	04-2000-20-700	04-2000-20-700
2	O-Ring (-225), End Cap (1.859" x .139")	1	04-2390-52-700	04-2390-52-700	04-2390-52-700	04-2390-52-700
3	End Cap, Pro-Flo™	1	04-2330-20-700	04-2330-20-700	04-2330-20-700	04-2330-20-700
4	Screw, HHC, Air Valve (1/4" x 4.5")	4	01-6000-03	01-6000-03	01-6000-05	01-6000-05
5	Screw, SHCS, 10-16 x 1 3/4"	2	04-6351-03	04-6351-03	04-6351-03	04-6351-03
6	Muffler Plate, Pro-Flo™	1	04-3180-20-700	04-3180-20-700	04-3180-20-700	04-3180-20-700
7	Gasket, Muffler Plate	1	04-3500-52-700	04-3500-52-700	04-3500-52-700	04-3500-52-700
8	Gasket, Air Valve	1	04-2600-52-700	04-2600-52-700	04-2600-52-700	04-2600-52-700
9	Center Section Assembly	1	04-3110-20	04-3110-20	04-3110-20	04-3110-20
10	Bushing, Reducer	1	04-6950-20-700	04-6950-20-700	04-6950-20-700	04-6950-20-700
11	Nut, Square, 1/4"-20	4	00-6505-03	00-6505-03	00-6505-03	00-6505-03
12	Sleeve, Threaded, Pro-Flo™ Center Block	4	04-7710-08	04-7710-08	04-7710-08	04-7710-08
13	Removable Pilot Sleeve Assembly	1	04-3880-99	04-3880-99	04-3880-99	04-3880-99
14	Shaft, Pro-Flo™	1	08-3810-09	08-3810-09	08-3810-09	08-3810-09
	Shaft, Pro-Flo™, Ultra-Flex™	1	08-3841-03	08-3841-03	08-3841-03	08-3841-03
15	Glyd Ring	2	08-3210-55-225	08-3210-55-225	08-3210-55-225	08-3210-55-225
16	Gasket, Center Block, Pro-Flo™	2	04-3526-52	04-3526-52	04-3526-52	04-3526-52
17	Air Chamber, Pro-Flo™	2	08-3651-01	08-3651-01	08-3651-01	08-3651-01
18	Screw, HSFHS, 3/8"-16 x 1"	8	71-6250-08	71-6250-08	71-6250-08	71-6250-08
19	Retaining Ring	2	04-3890-03	04-3890-03	04-3890-03	04-3890-03
20	Inner Piston	2	04-3700-01	04-3700-01	04-3700-01	04-3700-01
	Inner Piston, Ultra-Flex™	2	08-3761-01	08-3761-01	08-3761-01	08-3761-01
21	Diaphragm	2	*	*	*	*
22	Outer Piston	2	04-4550-21-500	04-4550-21-500	04-4550-21-500	04-4550-21-500
	Outer Piston, Ultra-Flex™	2	08-4560-21	08-4560-21	08-4560-21	08-4560-21
23	Manifold Tee Section	2	08-5160-20	08-5160-21	08-5160-20	08-5160-21
24	Small Clamp Band Assy.	4	08-7100-03-500	08-7100-03-500	08-7100-05-500	08-7100-05-500
25	Small HHC Screw (5/16"-18x2")	8	08-6050-03-500	08-6050-03-500	08-6050-05-500	08-6050-05-500
26	Small Square Nut	8	08-6400-03	08-6400-03	08-6400-05	08-6400-05
27	Manifold O-Ring	4	*	*	*	*
28	Inlet Elbow	2	08-5220-20	08-5220-21	08-5220-20	08-5220-21
29	Medium Clamp Band Assy.	4	08-7200-03-500	08-7200-03-500	08-7200-05-500	08-7200-05-500
30	Medium Hex Nut (5/16"-18)	8	08-6400-03	08-6400-03	08-6400-05	08-6400-05
31	Medium Carriage Bolt (5/16"-18 x 2 1/4")	8	04-6070-03	04-6070-03	04-6070-05	04-6070-05
32	Valve Seat	4	08-1120-20-500	08-1120-21-500	08-1120-20-500	08-1120-21-500
33	Valve Seat, O-Ring (2.609" x .139")	4	*	*	*	*
34	Valve Ball	4	*	*	*	*
35	Ball Guide Bushing	4	08-5350-20-500	08-5350-21-500	08-5350-20-500	08-5350-21-500
36	Liquid Chamber	2	08-5000-20	08-5000-21	08-5000-20	08-5000-21
37	Discharge Elbow	2	08-5230-20	08-5230-21	08-5230-20	08-5230-21
38	Large Clamp Band Assy.	2	08-7300-03-500	08-7300-03-500	08-7300-05-500	08-7300-05-500
39	Large Carriage Bolt	4	08-6070-03-500	08-6070-03-500	08-6070-05-500	08-6070-05-500
40	Large Hex Nut (3/8"-16)	4	08-6450-03	08-6450-03	08-6420-05	08-6420-05
41	Pilot Spool Retaining O-Ring	2	08-2650-49-700	08-2650-49-700	08-2650-49-700	08-2650-49-700

¹Air Valve Assembly includes items 2 and 3.

²Refer to corresponding elastomer options in Section 10.

-502 Specialty Code = PFA-Coated Hardware



# SECTION 9B

# EXPLODED VIEW/PARTS LISTING

# P8

PLASTIC  
TEFLON®-  
FITTED

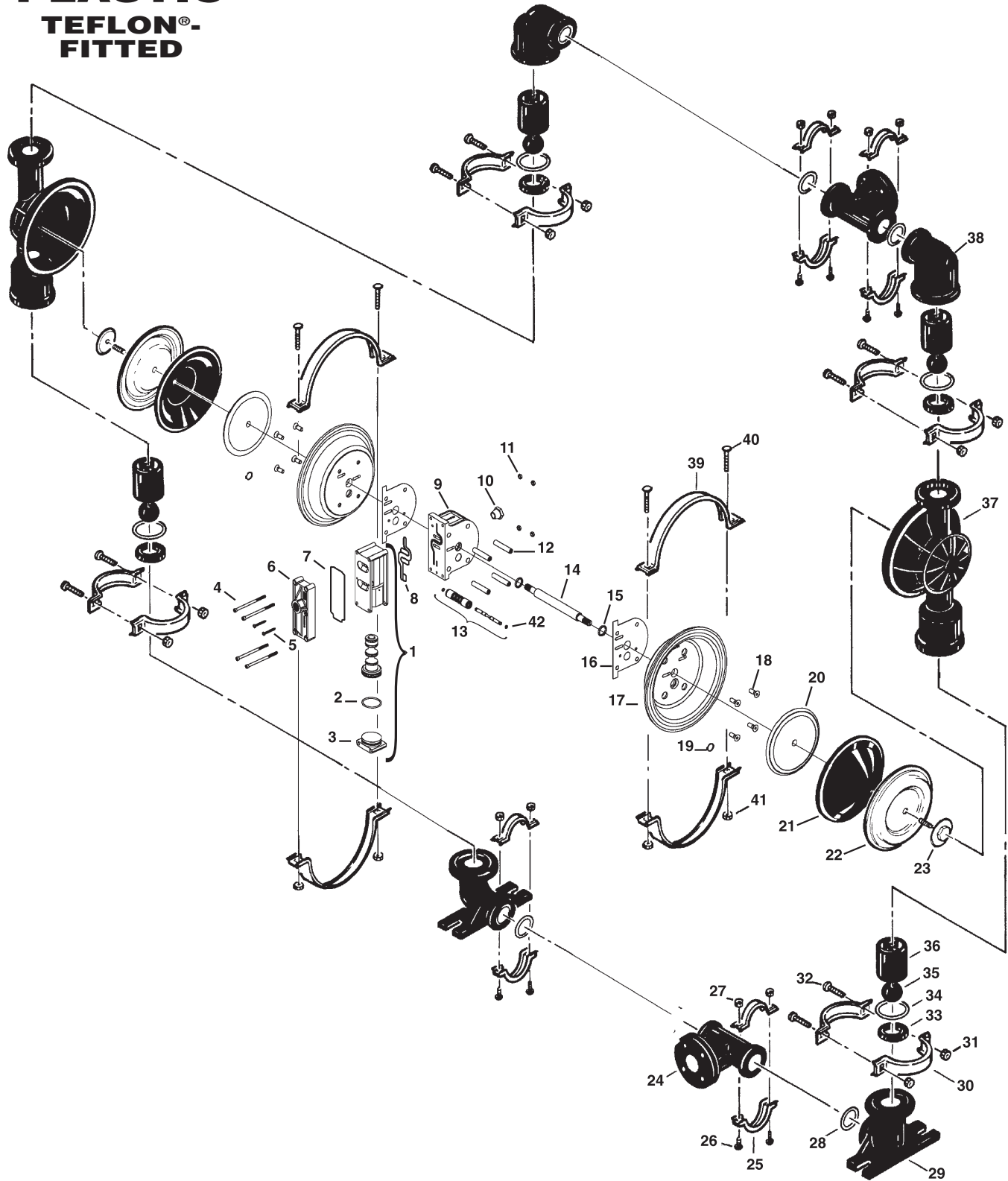

## P8 Plastic, Teflon®-Fitted

Item #	Part Description	Qty. per Pump	P8/PAPP P/N	P8/KAPP P/N	P8/PAPP-502 P/N	P8/KAPP-502 P/N
1	Pro-Flo™ Air Valve Assembly <sup>1</sup>	1	04-2000-20-700	04-2000-20-700	04-2000-20-700	04-2000-20-700
2	O-Ring (-225), End Cap (1.859" x .139")	1	04-2390-52-700	04-2390-52-700	04-2390-52-700	04-2390-52-700
3	End Cap, Pro-Flo™	1	04-2330-20-700	04-2330-20-700	04-2330-20-700	04-2330-20-700
4	Screw, HHC, Air Valve (1/4" x 4.5")	4	01-6000-03	01-6000-03	01-6000-05	01-6000-05
5	Screw, SHCS, 10-16 x 1 3/4"	2	04-6351-03	04-6351-03	04-6351-03	04-6351-03
6	Muffler Plate, Pro-Flo™	1	04-3180-20-700	04-3180-20-700	04-3180-20-700	04-3180-20-700
7	Gasket, Muffler Plate	1	04-3500-52-700	04-3500-52-700	04-3500-52-700	04-3500-52-700
8	Gasket, Air Valve	1	04-2600-52-700	04-2600-52-700	04-2600-52-700	04-2600-52-700
9	Center Section Assembly	1	04-3110-20	04-3110-20	04-3110-20	04-3110-20
10	Bushing, Reducer	1	04-6950-20-700	04-6950-20-700	04-6950-20-700	04-6950-20-700
11	Nut, Square, 1/4"-20	4	00-6505-03	00-6505-03	00-6505-03	00-6505-03
12	Sleeve, Threaded, Pro-Flo™ Center Block	4	04-7710-08	04-7710-08	04-7710-08	04-7710-08
13	Removable Pilot Sleeve Assembly	1	04-3880-99	04-3880-99	04-3880-99	04-3880-99
14	Shaft, Pro-Flo™	1	08-3840-09	08-3840-09	08-3840-09	08-3840-09
15	Glyd Ring	2	08-3210-55-225	08-3210-55-225	08-3210-55-225	08-3210-55-225
16	Gasket, Center Block, Pro-Flo™	2	04-3526-52	04-3526-52	04-3526-52	04-3526-52
17	Air Chamber, Pro-Flo™	2	08-3651-01	08-3651-01	08-3651-01	08-3651-01
18	Screw, HSFHS, 3/8"-16 x 1"	8	71-6250-08	71-6250-08	71-6250-08	71-6250-08
19	Retaining Ring	2	04-3890-03	04-3890-03	04-3890-03	04-3890-03
20	Inner Piston	2	08-3750-01	08-3750-01	08-3750-01	08-3750-01
21	Diaphragm, Back-up	2	08-1060-51	08-1060-51	08-1060-51	08-1060-51
22	Diaphragm	2	08-1010-55	08-1010-55	08-1010-55	08-1010-55
23	Outer Piston	2	08-4600-21-500	08-4600-21-500	08-4600-21-500	08-4600-21-500
24	Manifold Tee Section	2	08-5160-20	08-5160-21	08-5160-20	08-5160-21
25	Small Clamp Band Assy.	4	08-7100-03-500	08-7100-03-500	08-7100-05-500	08-7100-05-500
26	Small HHC Screw (5/16"-18)	8	08-6050-03-500	08-6050-03-500	08-6050-05-500	08-6050-05-500
27	Small Square Nut	8	08-6400-03	08-6400-03	08-6400-05	08-6400-05
28	Manifold O-Ring	4	08-1300-60-500	08-1300-60-500	08-1300-60-500	08-1300-60-500
29	Inlet Elbow	2	08-5220-20	08-5220-21	08-5220-20	08-5220-21
30	Medium Clamp Band Assy.	4	08-7200-03-500	08-7200-03-500	08-7200-05-500	08-7200-05-500
31	Medium Hex Nut (5/16"-18)	8	08-6400-03	08-6400-03	08-6400-05	08-6400-05
32	Medium Carriage Bolt (5/16"-18 x 2 1/4")	8	04-6070-03	04-6070-03	04-6070-05	04-6070-05
33	Valve Seat	4	08-1120-20-500	08-1120-21-500	08-1120-20-500	08-1120-21-500
34	Valve Seat, O-Ring (2.609" x .139")	4	08-1200-60-500	08-1200-60-500	08-1200-60-500	08-1200-60-500
35	Valve Ball	4	08-1080-55	08-1080-55	08-1080-55	08-1080-55
36	Ball Guide Bushing	4	08-5350-20-500	08-5350-21-500	08-5350-20-500	08-5350-21-500
37	Liquid Chamber	2	08-5000-20	08-5000-21	08-5000-20	08-5000-21
38	Discharge Elbow	2	08-5230-20	08-5230-21	08-5230-20	08-5230-21
39	Large Clamp Band Assy.	2	08-7300-03-500	08-7300-03-500	08-7300-05-500	08-7300-05-500
40	Large Carriage Bolt (3/8"-16 x 2 1/2")	4	08-6070-03-500	08-6070-03-500	08-6070-05-500	08-6070-05-500
41	Large Hex Nut (3/8"-16)	4	08-6450-03	08-6450-03	08-6420-05	08-6420-05
42	Pilot Spool Retaining O-Ring	2	08-2650-49-700	08-2650-49-700	08-2650-49-700	08-2650-49-700

<sup>1</sup>Air Valve Assembly includes item numbers 2 and 3.

-502 Specialty Code = PFA-Coated Hardware



# SECTION 10

## ELASTOMER OPTIONS

---

### P8 Plastic

Material	Traditional Diaphragms (2)	Ultra-Flex™ Diaphragms (2)	Valve Seat O-Rings (4)	Manifold O-Rings (4)	Valve Ball (4)
Polyurethane	08-1010-50	N/A	08-1200-50-500	08-1300-50-500	08-1080-50
Neoprene	08-1010-51	08-1020-51	N/A	N/A	08-1080-51
Buna-N	08-1010-52	08-1020-52	08-1200-52-500	08-1300-52-500	08-1080-52
Nordel® (EPDM)	08-1010-54	08-1020-54	N/A	N/A	08-1080-54
Viton®	08-1010-53	08-1020-53	N/A	N/A	08-1080-53
Saniflex™	08-1010-56	N/A	N/A	N/A	08-1080-56
Teflon® PTFE	08-1010-55 <sup>3</sup>	N/A	N/A	N/A	08-1080-55
Neoprene Backup	08-1060-51	N/A	N/A	N/A	N/A
Wil-Flex™	08-1010-58	N/A	08-1200-58-500	08-1300-58-500	08-1080-58
Teflon® Encap. (Viton®)	N/A	N/A	08-1200-60-500	08-1300-60-500	N/A

#### NOTES

Teflon®-encapsulated Viton® O-rings, P/N 08-1200-60-500 and P/N 08-1300-60-500, are standard on all Teflon®-fitted pumps. Teflon® diaphragm, P/N 08-1010-55, must be used with Neoprene back-up diaphragms, P/N 08-1060-51.







## WARRANTY

Each and every product manufactured by Wilden Pump and Engineering Company is built to meet the highest standards of quality. Every pump is functionally tested to insure integrity of operation.

Wilden Pump and Engineering Company warrants that pumps, accessories and parts manufactured of supplied by it to be free from defects in material and workmanship for a period of one year from date of startup or two years from date of shipment, whichever comes first. Failure due to normal wear, misapplication, or abuse is, or course, excluded from this warranty.

Since the use of Wilden pumps and parts is beyond our control, we cannot guarantee the suitability of any pump or part for a particular application and Wilden Pump and Engineering Company shall not be liable for any consequential damage or expense arising from the use or misuse of its products on any application. Responsibility is limited solely to replacement or repair of defective Wilden pumps and parts.

All decisions as to the cause of failure are the sole determination of Wilden Pump and Engineering Company.

Prior approval must be obtained from Wilden for return of any items for warranty consideration and must be accompanied by the appropriate MSDS for the product(s) involved. A Return Goods Tag, obtained from an authorized Wilden distributor, must be included with the items which must be shipped freight prepaid.

The foregoing warranty is exclusive and in lieu of all other warranties expressed or implied (whether written or oral) including all implied warranties of merchantability and fitness for any particular purpose. No distributor or other person is authorized to assume any liability or obligation for Wilden Pump and Engineering Company other than expressly provided herein.

### PLEASE PRINT OR TYPE AND FAX TO WILDEN

Item # \_\_\_\_\_ Serial # \_\_\_\_\_

Company Purchased From \_\_\_\_\_

Your Company Name \_\_\_\_\_

Industry \_\_\_\_\_

Your Name \_\_\_\_\_ Title \_\_\_\_\_

Your Address (Street) \_\_\_\_\_

(City) \_\_\_\_\_ (State) \_\_\_\_\_ (Postal Code) \_\_\_\_\_ (Country) \_\_\_\_\_

(Telephone) \_\_\_\_\_ (Fax) \_\_\_\_\_ (e-mail) \_\_\_\_\_

Number of pumps in facility? \_\_\_\_\_ Diaphragm \_\_\_\_\_ Centrifugal

\_\_\_\_\_ Gear \_\_\_\_\_ Submersible \_\_\_\_\_ Lobe \_\_\_\_\_ Other \_\_\_\_\_

Chemical(s) being pumped \_\_\_\_\_

How did you hear of Wilden Pump? \_\_\_\_\_ Trade Journal \_\_\_\_\_ Trade Show

\_\_\_\_\_ Internet/E-mail \_\_\_\_\_ Distributor \_\_\_\_\_ Other \_\_\_\_\_

**ONCE COMPLETE, FAX TO (909) 783-3440**

NOTE: WARRANTY VOID IF PAGE IS NOT FAXED TO WILDEN